

PENIMASTER[®] PRO





de



PeniMaster® ist eine eingetragene Marke
von MSP Concept GmbH & Co. KG
Patent-Nr. DE 10 2007 026 063
Gebrauchsmuster-Nr. DE 20 2008 014 196
Gebrauchsmuster-Nr. DE 20 2009 001 971
Gebrauchsmuster-Nr. DE 20 2007 008 831
Gebrauchsmuster-Nr. DE 20 2007 016 874
Gebrauchsmuster-Nr. DE 20 2007 016 875

© Copyright 2018 MSP Concept GmbH & Co. KG
Stand: 02/2018. Alle Rechte vorbehalten.

Copyright

Die vorliegende Dokumentation ist urheberrechtlich geschützt. Alle Rechte, insbesondere das Recht zur Vervielfältigung und Verbreitung sowie der Übersetzung, bleiben vorbehalten.

Kein Teil dieser Publikation darf ohne schriftliche Genehmigung des Rechteinhabers in irgendeiner Form durch Fotokopie, Mikrofilm oder andere Verfahren reproduziert oder in eine für Maschinen, insbesondere Datenverarbeitungsanlagen, verwendbaren Sprache übertragen werden.

Sämtliche Wiedergaberechte bleiben vorbehalten.

Irrtum und inhaltliche Änderungen sowie Änderungen, die dem technischen Fortschritt dienen, bleiben vorbehalten.



Stückliste und Teilebenennung PeniMaster® PRO (Gewichte-Zugkraftherzeuger)

Art.-Nr. ZPMP-007

de



2



2.6

- 1 PeniMaster®PRO Basissystem**
Art.-Nr. PMP-001
(nicht im Lieferumfang erhalten)

- 2 Gewichte-Zugkraftherzeuger für PeniMaster®PRO System**
Art.-Nr. ZPMP-007

Basissystem (2.1) mit Sicherungssystem (2.1) und verschraubbaren Rundgewichten (2.6) aus Edelstahl. Zugkraft in Schritten von 125 Gramm einstellbar (von 250 g bis 1250 g). Mit Zusatzgewichten beliebig erweiterbar.

- 2.1 Basisgewicht 250 g**
Art.-Nr. ZPMP-008
Rundgewicht mit Innengewinde zum Anschrauben von Zusatzgewichten (2.6) und integrelem Sicherheitssystem (2.3 – 2.5).

- 2.2 Kupplungspfanne**
Verbindet den Gewichte-Zugkraftherzeuger (2) mit PeniMaster®PRO (1).

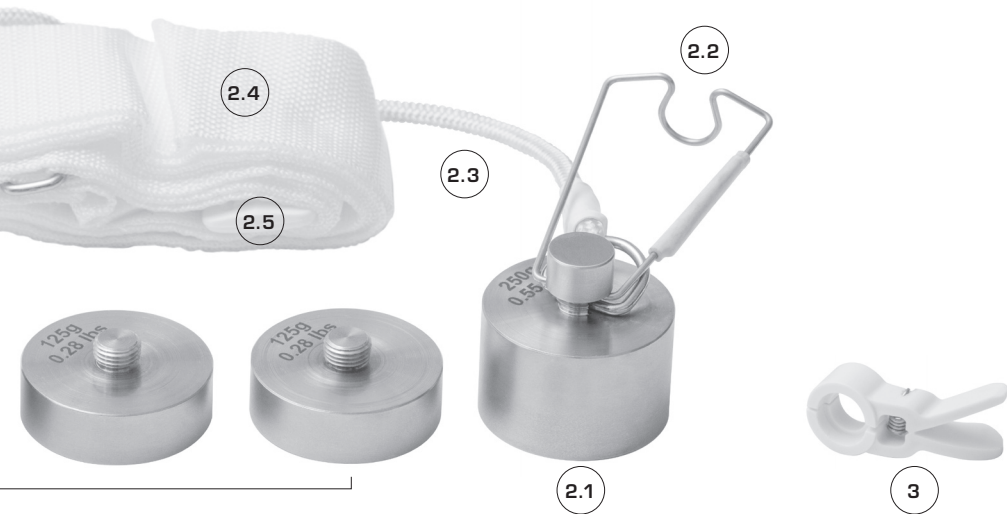

2.3 Fangseil
Reißfest, mit unlösbarer Verbindung zum Basisgewicht.

2.4 Schultergurt
Breiter, hautfreundlicher Gewebegurt. Wird wie eine Schärpe um die Schulter getragen.

2.5 Leiterschnallen
Zur Längenverstellung des Schultergurts (2.4).

2.6 Rundgewichte
Rundgewichte aus Edelstahl. Werden an das Basisgewicht (250 g) (2.1) und ineinander geschraubt.

Im Lieferumfang enthalten:
2 x 125 g (ZPMP-009),
1 x 250 g (ZPMP-010),
1 x 500 g (ZPMP-011).

3 Kupplungs-Sicherung
Art.-Nr. ZPMP-012
Sichert die Verbindung von PeniMaster®PRO (1) und Gewichte-Zugkraftrezeu-
ger (2) durch Fixierung der Kupplungs-
pfanne (2.2).

Anlegen Gewichte-Expander

Bevor Sie beginnen

Der Gewichte-Expander ist ein Zubehör zur PeniMaster®PRO Basis. Bitte lesen Sie daher auch die Bedienungsanleitung der PeniMaster®PRO Basis zur korrekten Handhabung sowie zu Risiken und Nebenwirkungen.

Gefahrenhinweise

Von den verwendeten Gewichten geht prinzipiell eine kinetische Gefahr (Fallenergie) aus!

- Legen Sie aus Sicherheitsgründen immer den Schultergurt um, und verwenden Sie die Kupplungs-Sicherung gemäß dieser Anleitung.
- Lassen Sie den am Penis angelegte Gewichte-Expander nicht nach unten fallen! Schon aus wenigen Zentimetern Fallhöhe besteht Verletzungsgefahr!
- Bewegen Sie sich mit am Penis angelegtem Gewichte-Expander langsam und kontrolliert. Hüpfen oder springen Sie nicht auf und ab. Gehen Sie Treppen langsam auf- und abwärts. Führen Sie keine sportlichen Aktivitäten aus.

Vorbereitung zum Anlegen.

[!] Sie müssen PeniMaster®PRO bereits am Penis angelegt haben (siehe Seite 20 ff. der Anleitung von PeniMaster®PRO).

1. Anlegen als Gewichte-Expander

- a) Schlüpfen Sie mit einem Arm durch den Gurt und ziehen diesen über den Kopf. Am Körper angelegt muss die Leiterschleife (2.5) nach vorne zeigen.

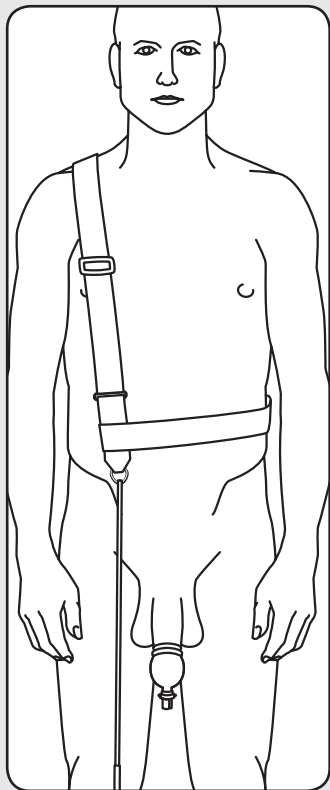

a) anlegen

- b) Mit der Leiterschnalle (2.5) verstellen Sie den Schultergurt (2.4) so, dass dessen Ende (mit dem Metallring) sich in etwa auf Höhe des Bauchnabels befindet.

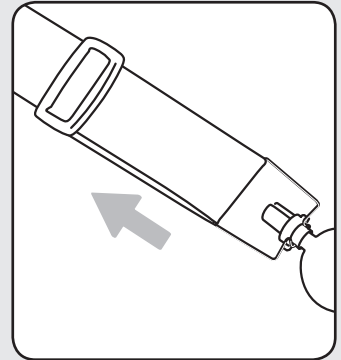

b) Länge einstellen mit
Leiterschnalle

- c) Drücken Sie das schmale Segment des Kupplungskopfes von PeniMaster®PRO (1) in die Ausbuchtung der Kupplungspfanne (2.2) und ziehen Sie am Basisgewicht (2.1). Hierdurch werden beide Teile miteinander verkuppelt.

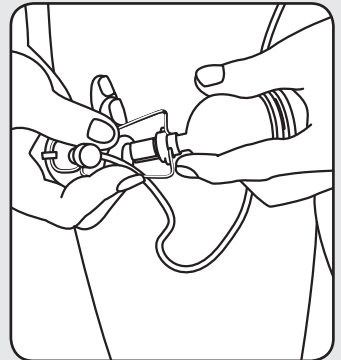

c) verkuppeln

- d) Öffnen Sie die Kupplungs-Sicherung (3) durch Zusammen drücken der Flügel und klemmen die Kupplungs-Sicherung (3) wie dargestellt auf PeniMaster®PRO (1).

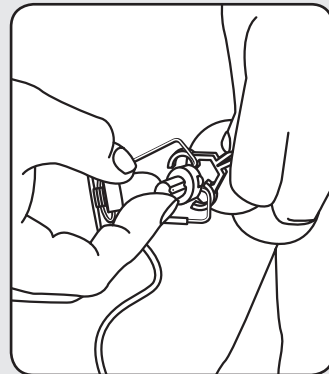

d) Kupplungs-Sicherung aufklemmen

- e) Erhöhen Sie die Zugkraft nach Wunsch durch An- und In einanderschrauben entsprechender Rundgewichte (2.6) an das Basisgewicht (2.1). (Hinweis: Dieser Schritt kann auch vor Schritt c) erfolgen, wenn Sie die gewünschte Zugkraft bereits kennen).

Folgende Zugkräfte können mit dem Gewichte-Set (2.6) eingestellt werden:

- 250 g = Basisgewicht
- 375 g = Basisgewicht + 125 g
- 500 g = Basisgewicht + 250 g
- 625 g = Basisgewicht + 125 g + 250 g
- 750 g = Basisgewicht + 500 g
- 875 g = Basisgewicht + 125 g + 500 g
- 1000 g = Basisgewicht + 250 g + 500 g
- 1125 g = Basisgewicht + 125 g + 250 g + 500 g
- 1250 g = Basisgewicht + 125 g + 125 g + 250 g + 500 g

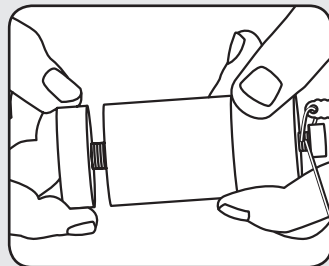

e) Zugkräfte einstellen

Hinweis: Die Zugkraft kann durch Zusatzgewichte (nicht im Lieferumfang enthalten) weiter erhöht werden.

Korrekt angelegtes Gewichte-Expandersystem.

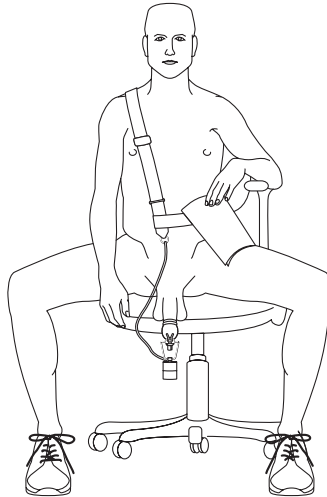

Varianten

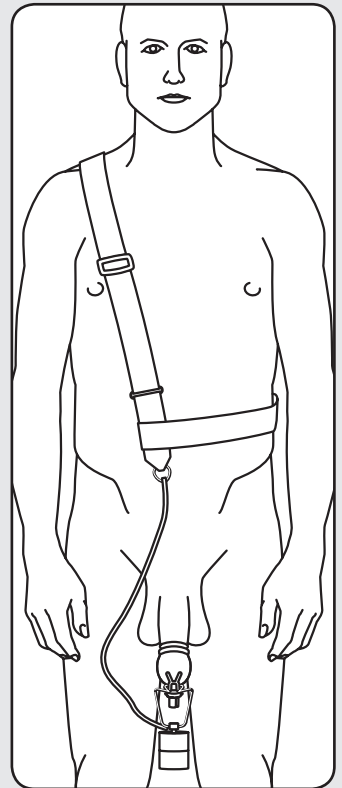
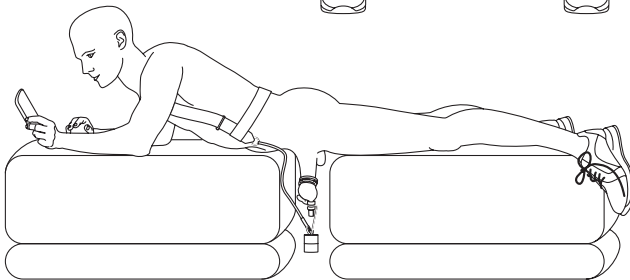

korrekt angelegt

Impressum

**Hersteller des Penis-Expandersystems PeniMaster®PRO und
Herausgeber dieses Handbuchs und dieser Gebrauchsanleitung**

MSP Concept GmbH & Co. KG
Emser Str. 39d
D-10719 Berlin

Fon: +49 (0)30/23 63 85 65
Fax: +49 (0)30/21 75 26 11
E-Mail: info@penimaster.de

Amtsgericht Charlottenburg
HRA 33128
USt-IdNr.: DE202064651

diese vertreten durch die

MSP Concept Verwaltungs GmbH
Sitz: Berlin
Amtsgericht Charlottenburg
HRB 83666

diese vertreten durch den

Geschäftsführer
Matthias Suchy

Grafik
ab-design GmbH, Berlin

Manual



en



PeniMaster® is a registered trademark of
MSP Concept GmbH & Co. KG

Patent No. DE 10 2007 026 063

Utility model No. DE 20 2008 014 196

Utility model No. DE 20 2009 001 971

Utility model No. DE 20 2007 008 831

Utility model No. DE 20 2007 016 874

Utility model No. DE 20 2007 016 875

© Copyright 2018 MSP Concept GmbH & Co. KG

Last update: 02/2018. All rights reserved.

Copyright

The present documentation is protected by copyright. All rights, particularly the right of reproduction and distribution, as well as translation, shall remain reserved.

No part of this publication must be reproduced in any way by photocopy, microfilm or other procedures, or be transferred into a language processible by machines, particularly data processing machines, without the written consent of the holder of the rights.

All rights of reproduction shall remain reserved.

Errors and modifications to the contents, as well as modifications serving technological progress, shall remain reserved.



Parts list and designation of parts PeniMaster® PRO (Weight pulling force generator)

Art. No. ZPMP-007

en



- 1 PeniMaster® PRO Basic system**
Art. No. PMP-001
(not included)



- 2 Weight pulling force generator for PeniMaster® PRO system**
Art. No. ZPMP-007

Base weight (250 g) with safety system (2.1) and screw-mountable stainless steel round weights (2.6). Pulling force adjustable in steps of 125 g (between 250 g and 1,250 g). Freely expandable with additional weights.



- 2.1 Base weight 250 g**
Art. No. ZPMP-008
Round weight with internal thread for screw-mounting of additional weights (2.6) and integral safety belt (2.3 – 2.5).
- 2.2 Coupling socket**
Connects the weight pulling force generator (2) to PeniMaster® PRO (1).

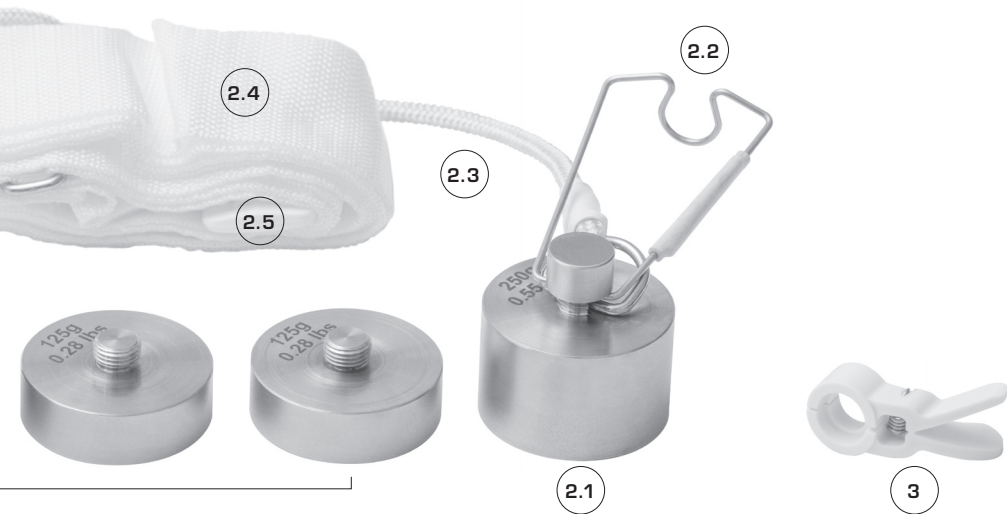

2.3 Safety cord
Tear-resistant, with fixed connection to the base weight.

2.4 Shoulder belt
Wide, eudermic tissue belt. Worn like a sash around the shoulders.

2.5 Ladder lock buckles
To adjust the length of the shoulder belt [2.4].

2.6 Round weights
Round weights made of stainless steel. Screw-mounted to the base weight (250 g) [2.1] and to each other.

Included:
2 x 125 g (ZPMP-009),
1 x 250 g (ZPMP-010),
1 x 500 g (ZPMP-011).

3 Coupling retainer
Art. No. ZPMP-012
Secures the connection of PeniMaster®PRO [1] and weight pulling force generator [2] by retaining the coupling socket [2.2].

Application weight expander

Before you start

The weight expander is an accessory for the PeniMaster®PRO basic system. Please therefore also read the PeniMaster®PRO basic system instructions on correct use and the risks and side effects.

en Safety notice

The weights used always pose a kinetic risk (drop energy)!

- For safety reasons, always wear the safety belt and use the coupling retainer according to these instructions.
- Do not let the weight expander attached to the penis drop! There is a risk of injury if dropped just a few centimetres!
- Make slow and controlled movements when the weight expander is attached to the penis. Do not bounce or jump up and down. Walk slowly up and down stairs. Do not engage in any sporting activities.

Preparation for application:

[!] PeniMaster®PRO already has to be applied to the penis (see page 20 et seq. of the instructions for PeniMaster®PRO).

1. Application as weight expander

- a) Slip one arm through the belt and pull it over your head. Worn on the body, the ladder lock buckle (2.5) must point towards the front.

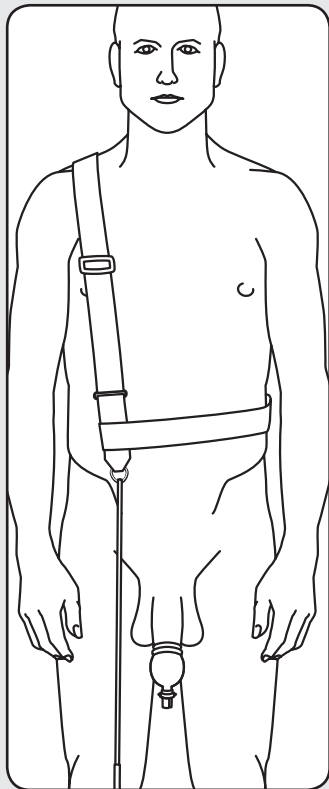

a) Apply

- b) Using the ladder lock buckle (2.5), adjust the shoulder belt (2.4) so that its end (with the metal ring) is approximately at navel level.

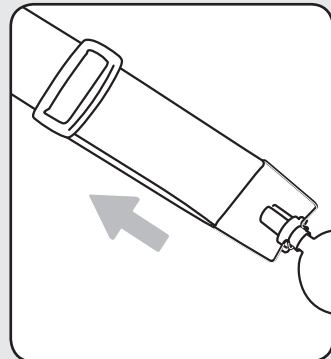

b) Adjust length using the ladder lock buckle

- c) Press the narrow segment of the coupling head of PeniMaster®PRO (1) into the protrusion of the coupling socket (2.2) and pull on the base weight (2.1). In doing so, both parts are coupled together.

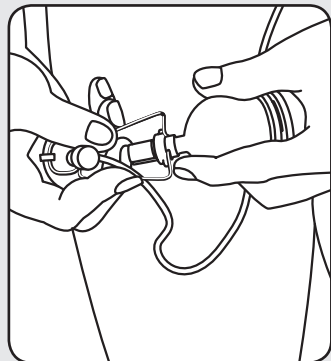

c) Couple together

- d) Open the coupling retainer (3) by pressing the wings together and clip the coupling retainer (3) on PeniMaster®PRO (1) as shown.

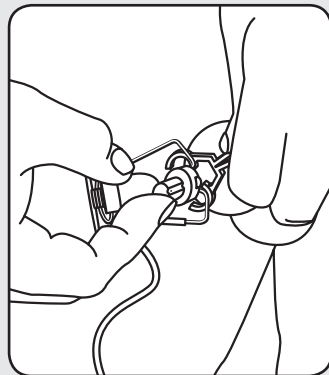

d) Clip on coupling retainer

- e) Increase the pulling force as needed by screw-mounting the appropriate round weights (2.6) to the base weight (2.1). (Note: You can also do this prior to step c) if you already know the needed pulling force).

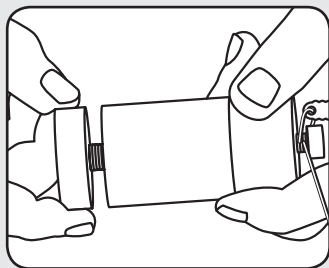

e) Adjust pulling forces

The following pulling forces can be adjusted with the weight set (2.6):

- 250 g = base weight
- 375 g = base weight + 125 g
- 500 g = base weight + 250 g
- 625 g = base weight + 125 g + 250 g
- 750 g = base weight + 500 g
- 875 g = base weight + 125 g + 500 g
- 1000 g = base weight + 250 g + 500 g
- 1125 g = base weight + 125 g + 250 g + 500 g
- 1250 g = base weight + 125 g + 125 g + 250 g + 500 g

Note: The pulling force can be further increased by additional weights (not included).

Correctly applied weight expander system.

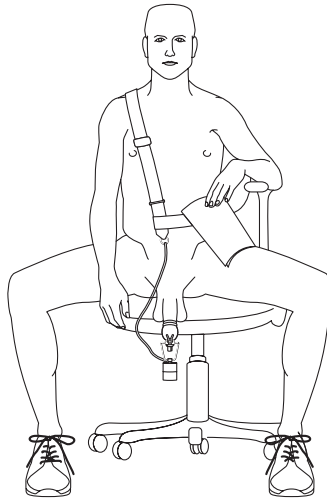

Variants

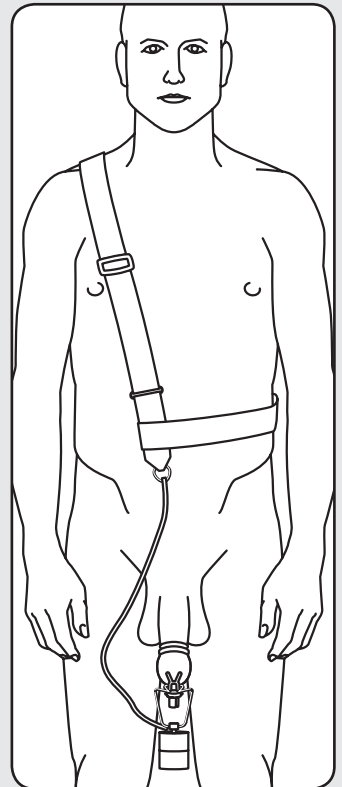
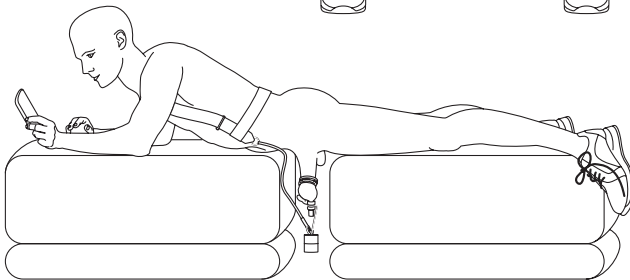

Correctly applied

Legal notice

Manufacturer of the penis expander system PeniMaster®PRO and publisher of this manual and these instructions for use

MSP Concept GmbH & Co. KG
Emser Str. 39d
D-10719 Berlin
Germany

Telephone: +49 (0)30 / 23 63 85 65
Fax: +49 (0)30 / 21 75 26 11
E-Mail: info@penimaster.de

District Court of Charlottenburg
Commercial Register A No. 33128
VAT ID No.: DE202064651

represented by

MSP Concept Verwaltungs GmbH
Place of business: Berlin
District Court of Charlottenburg
Commercial Register B No. 83666

represented by the

Managing Director
Matthias Suchy

Graphics
ab-design GmbH, Berlin



MSP CONCEPT
GMBH & CO. KG

PeniMaster® est une marque déposée de
MSP Concept GmbH & Co. KG

Brevet n° DE 10 2007 026 063

Modèle déposé n° DE 20 2008 014 196

Modèle déposé n° DE 20 2009 001 971

Modèle déposé n° DE 20 2007 008 831

Modèle déposé n° DE 20 2007 016 874

Modèle déposé n° DE 20 2007 016 875

© Droit d'auteur 2018 MSP Concept GmbH & Co. KG

Version : 02/2018. Tous droits réservés.

Droit d'auteur

La présente documentation est protégée par les droits de la propriété intellectuelle. Tous les droits, notamment le droit relatif à la reproduction, à la diffusion et à la traduction, demeurent réservés.

Il est interdit de reproduire toute partie de cette publication de quelle forme que ce soit (photocopie, microfilm ou autres procédés) ou de la transcrire dans un langage pouvant être utilisé par une machine (en particulier les ordinateurs), sans un accord écrit du titulaire de droits.

Tous les droits de diffusion demeurent réservés.

Sous réserve d'erreurs, de modifications du contenu et de modifications dans l'intérêt du progrès technologique.



Liste et désignation des pièces du PeniMaster® PRO (générateur de force de traction à poids)

N° art. ZPMP-007



- 1** PeniMaster® PRO
Système de base
N° art. PMP-001
(non fourni)

- 2** Générateur de force de
traction à poids pour le
système PeniMaster® PRO
N° art. ZPMP-007

Poids de base (250 g) avec système de sécurité (2.1) et poids ronds vissables (2.6) en acier inoxydable. Force de traction réglable par intervalle de 125 grammes (de 250 g à 1250 g). Extensible à volonté avec les poids supplémentaires.

- 2.1** Poids de base 250 g
N° art. ZPMP-008

Poids rond avec filetage intérieur pour visser les poids supplémentaires (2.6) et sangle de sécurité intégrale (2.3 – 2.5).

- 2.2** Élément de liaison

Relie le générateur de force de traction à poids (2) au PeniMaster® PRO (1).

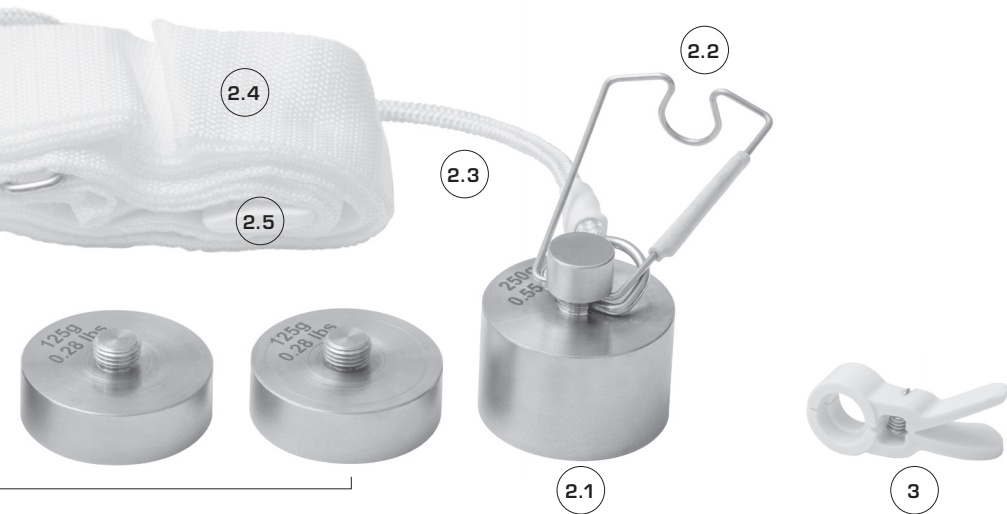

2.3 Corde de sécurité
Indéchirable, avec une liaison permanente au poids de base.

2.4 Sangle d'épaule
Sangle en tissu large et douce pour la peau. Portée sur l'épaule comme une écharpe.

2.5 Boucles
Pour adapter la longueur de la sangle en tissu (2.4).

2.6 Poids ronds
Poids ronds en acier inoxydable. Sont vissés ensemble et au poids de base (250 g) (2.1).

Fournis :
2 x 125 g (ZPMP-009),
1 x 250 g (ZPMP-010),
1 x 500 g (ZPMP-011).

3 Sécurité d'accouplement
N° art. ZPMP-012
Garantit la liaison entre le PeniMaster®PRO (1) et le générateur de force de traction à poids (2) par la fixation de l'élément de liaison (2.2).

Mise en place de l'extenseur à poids

Avant de commencer

L'extenseur à poids est un accessoire du PeniMaster®PRO Basis. Veuillez donc également lire les sections concernant la manipulation correcte ainsi que les risques et les effets secondaires dans la notice d'utilisation de PeniMaster®PRO Basis.

Remarques relatives aux risques

Les poids utilisés représentent généralement un risque cinétique (énergie de chute) !

- Pour des raisons de sécurité, mettez toujours la sangle d'épaule et utilisez la sécurité d'accouplement conformément à cette notice.
- Ne laissez pas tomber l'extenseur à poids mis en place sur le pénis ! Même une chute de quelques centimètres de haut présente un risque de blessure !
- Déplacez-vous doucement et de manière contrôlée avec l'extenseur à poids mis en place sur le pénis. Ne sautillez ni ne sautez pas sur place. Montez et descendez doucement les escaliers. Ne pratiquez aucune activité sportive.

Préparation à la mise en place.

[!] Vous devez déjà avoir mis en place le PeniMaster®PRO sur le pénis (cf. page 20 et suivantes du mode d'emploi du PeniMaster®PRO).

1. Mise en place comme extenseur à poids

- a) Passez un bras dans la sangle puis enfilez-la par la tête. Posée contre le corps, la boucle (2.5) doit être dirigée vers l'avant.

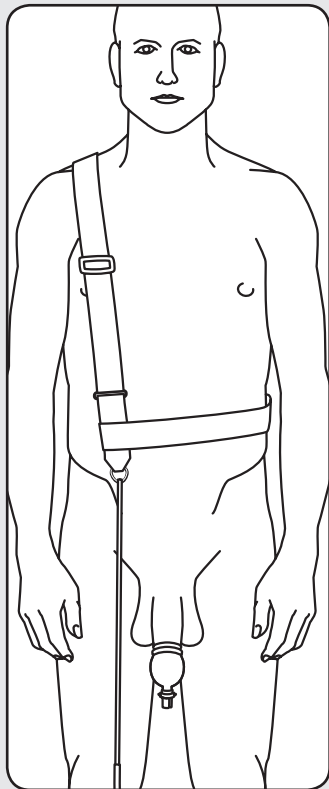

a) Mise en place

- b) La boucle (2.5) vous permet d'ajuster la sangle d'épaule (2.4) de manière à ce que son extrémité (avec l'anneau métallique) se trouve environ à hauteur de votre nombril.

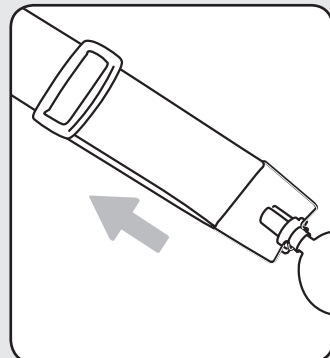

b) Ajustement de la longueur avec la boucle

- c) Enfoncez le segment mince de la tête d'accouplement du PeniMaster®PRO (1) dans l'échancrure de l'élément de liaison (2.2) et tirez sur le poids de base (2.1). Cela permet de raccorder ces deux éléments.

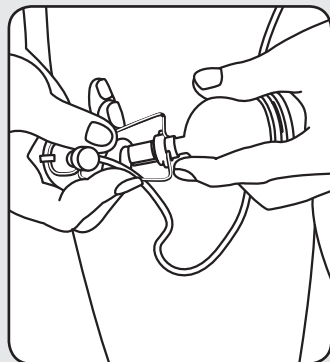

c) Accouplement

d) Ouvrez la sécurité d'accouplement (3) en appuyant sur les ailettes puis attachez la sécurité d'accouplement (3) au PeniMaster®PRO (1) comme dans la figure ci-contre.

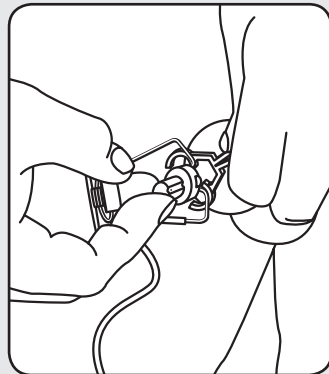

d) Fixation de la sécurité d'accouplement

fr e) Augmentez la force de traction à volonté en vissant les poids ronds (2.6) appropriés ensemble et au poids de base (2.1). (Remarque : Cette étape peut aussi avoir lieu avant l'étape c), si vous connaissez déjà la force de traction désirée).

Les forces de traction peuvent être ajustées avec le jeu de poids (2.6) :

- 250 g = poids de base
- 375 g = poids de base + 125 g
- 500 g = poids de base + 250 g
- 625 g = poids de base + 125 g + 250 g
- 750 g = poids de base + 500 g
- 875 g = poids de base + 125 g + 500 g
- 1000 g = poids de base + 250 g + 500 g
- 1125 g = poids de base + 125 g + 250 g + 500 g
- 1250 g = poids de base + 125 g + 125 g + 250 g + 500 g

Remarque : La force de traction peut être augmentée davantage avec les poids supplémentaires (non fournis).

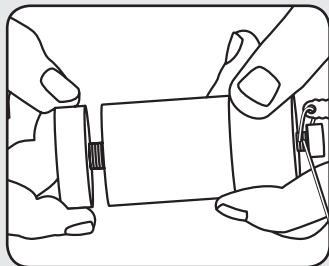

e) Ajustement des forces de traction

Système extenseur à poids correctement mis en place.

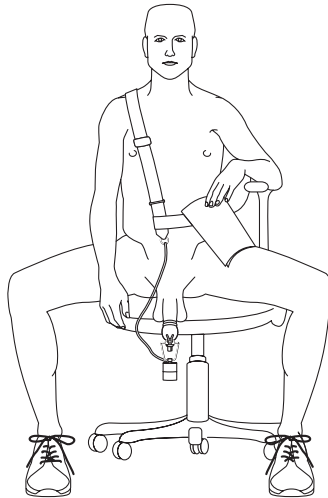

Variantes

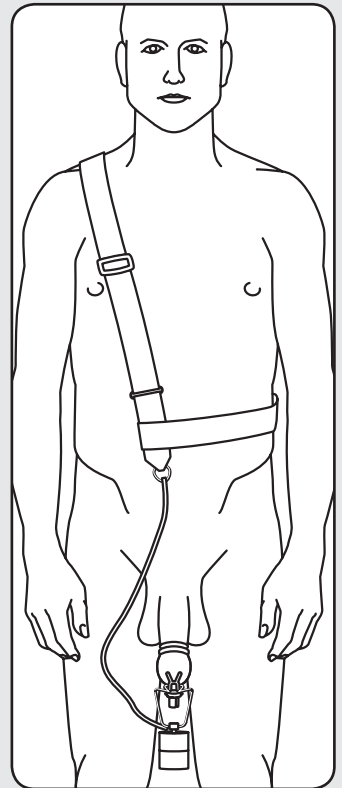
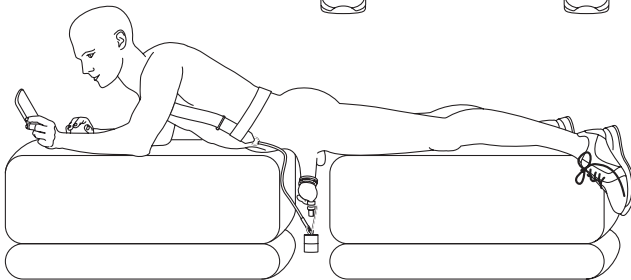

Mis en place correctement

Mentions légales

Fabricant du système d'extension pénienne PeniMaster® PRO et éditeur du présent manuel et mode d'emploi

MSP Concept GmbH & Co. KG
Emser Str. 39d
D-10719 Berlin

Téléphone : +49 (0)30/23 63 85 65
Télécopie : +49 (0)30/21 75 26 11
Courriel : info@penimaster.de

fr

Amtsgericht Charlottenburg (Tribunal d'instance)
HRA 33128
N° identification TVA : DE202064651

représentée par la société

MSP Concept Verwaltungs GmbH
Siège : Berlin
Amtsgericht Charlottenburg (Tribunal d'instance)
HRB 83666

représentée par le

Président-directeur général
Matthias Suchy

Illustrations
ab-design GmbH, Berlin

Istruzioni per l'uso



it

MSP CONCEPT
GMBH & CO. KG

PeniMaster® è un marchio registrato di

MSP Concept GmbH & Co. KG

Brevetto num. DE 10 2007 026 063

Modello di utilità num. DE 20 2008 014 196

Modello di utilità num. DE 20 2009 001 971

Modello di utilità num. DE 20 2007 008 831

Modello di utilità num. DE 20 2007 016 874

Modello di utilità num. DE 20 2007 016 875

© Copyright 2018 MSP Concept GmbH & Co. KG

Versione: 02/2018. Tutti i diritti riservati.

Copyright

La presente documentazione è tutelata da copyright. Rimangono riservati tutti i diritti, in particolare il diritto alla riproduzione, alla diffusione e alla traduzione.

Nessuna parte della presente pubblicazione può essere riprodotta in alcuna forma, attraverso fotocopia, microfilm o altri processi, senza l'autorizzazione scritta del titolare del diritto, né riprodotta o trasmessa in qualsiasi lingua utilizzabile per macchine, in particolare per sistemi di elaborazione dati.

Tutti i diritti di comunicazione rimangono riservati.

Salvo errori e modifiche contenutistiche, come pure modifiche conseguenti all'evoluzione tecnologica.



Elenco e descrizione dei pezzi PeniMaster® PRO (Dispositivo di trazione a pesi)

Num. art. ZPMP-007



- 1** **PeniMaster® PRO**
Sistema di base
Num. art. PMP-001
(non incluso nella fornitura)

- 2** **Dispositivo di trazione**
per il sistema
PeniMaster® PRO
Num. art. ZPMP-007
Peso di base (250 g) con sistema di sicurezza (2.1) e pesi circolari avvitabili (2.6) in acciaio inox. Trazione regolabile gradualmente da 125 grammi (da 250 g a 1250 g). Integrabili a piacere con pesi supplementari.

- 2.1** **Peso di base 250 g**
Num. art. ZPMP-008
Peso circolare con filettatura interna per avvitare i pesi supplementari (2.6) e cinghia di sicurezza integrale (2.3 – 2.5).
- 2.2** **Aggancio**
Unisce il dispositivo di trazione a pesi (2) a PeniMaster® PRO (1)

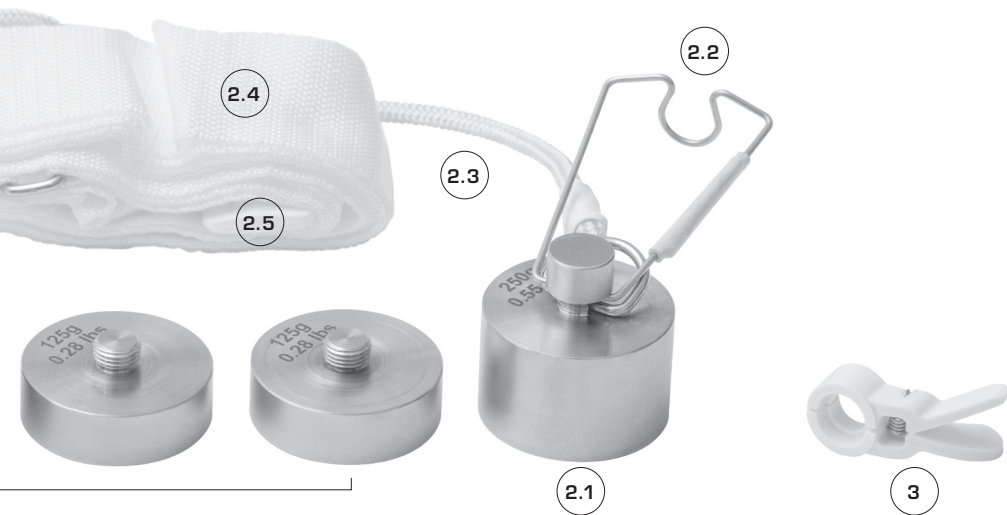

2.3 **Fune di presa**
Antistrappo, con collegamento fisso al peso di base.

2.4 **Cinghia scapolare**
Larga cinghia in tessuto, tollerata dalla pelle. È indossata attorno alle spalle come una fascia.

2.5 **Fibbie**
Per regolare la lunghezza della cinghia scapolare [2.4].

2.6 **Pesi circolari**
Pesi circolari in acciaio inox. Sono avvitati al peso di base [250 g] (2.1) e l'uno all'altro.

Inclusi nella fornitura:
2 x 125 g (ZPMP-009),
1 x 250 g (ZPMP-010),
1 x 500 g (ZPMP-011).

3 **Sicurezza di aggancio**
Num. art. ZPMP-012
Assicura il collegamento tra PeniMaster®PRO [1] e il dispositivo di trazione a pesi [2] grazie al fissaggio dell'aggancio [2.2].

Applicazione dell'expander a pesi

Prima di iniziare

L'expander a pesi è un accessorio del sistema di base PeniMaster®PRO. Leggete quindi anche le istruzioni per l'uso del sistema di base PeniMaster®PRO per un corretto impiego e per essere informati circa rischi ed effetti collaterali.

Indicazioni di pericolo

In linea di massima i pesi utilizzati comportano un pericolo cinetico (energia di caduta)!

- Per motivi di sicurezza indossate sempre la cinghia scapolare e utilizzate la sicurezza di aggancio secondo queste istruzioni.
- Non fate cadere a terra l'expander a pesi che avete messo sul pene! Già una caduta da pochi centimetri di altezza costituisce pericolo di lesioni!
- Muovetevi con l'expander a pesi messo sul pene lentamente e in modo controllato. Non saltellate o saltate su e giù. Salite e scendete le scale lentamente. Non eseguite attività sportive.

Preparativi per l'applicazione.

[!] Occorre già aver indossato sul pene PeniMaster®PRO (vedere pagina 20 e segg. delle Istruzioni per l'uso PeniMaster®PRO).

1. Applicazione come expander a pesi

- a) Inserire un braccio attraverso la cinghia e tirarla sopra la testa. Applicata al corpo, la fibbia (2.5) deve essere rivolta in avanti.

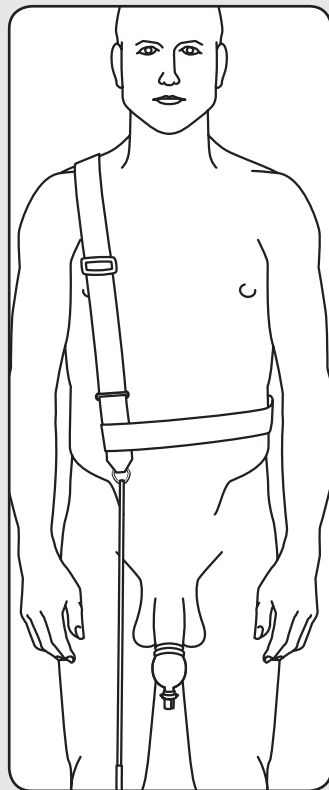

a) applicare

- b) Regolare con la fibbia (2.5) la cinghia scapolare (2.4) in modo tale che la sua estremità (con anello metallico) si trovi circa all'altezza dell'ombelico.

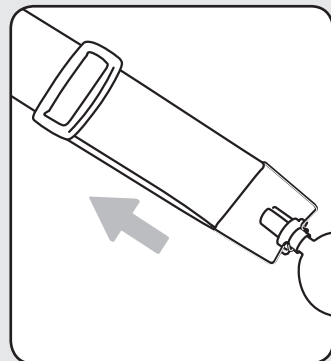

b) Regolare la lunghezza con la fibbia

- c) Spingere il segmento stretto della testina di attacco di PeniMaster®PRO (1) nell'incavo dell'aggancio (2.2) e tirare al peso di base (2.1). In questo modo si collegano saldamente i due pezzi.

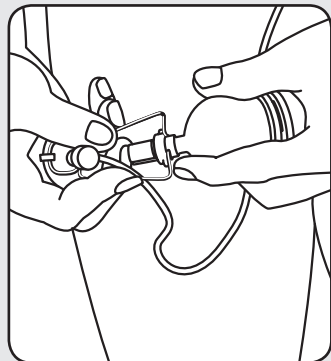

c) agganciare

d) Aprire la sicurezza di aggancio (3), premendo insieme le ali e fissare la sicurezza di aggancio (3) su PeniMaster®PRO (1), come rappresentato in figura.

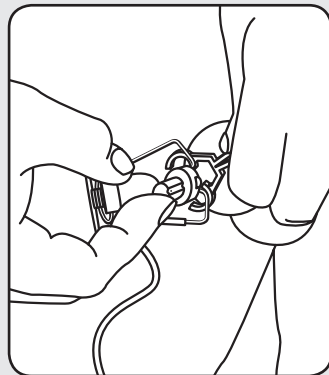

d) agganciare la sicurezza di aggancio

e) Aumentare la trazione a piacere, avvitando o svitando uno all'altro i pesi circolari corrispondenti (2.6) al peso di base (2.1). (Avviso: questo passaggio può essere svolto anche prima del passaggio c), se già si conosce la trazione desiderata).

Le seguenti trazioni possono essere regolate con il set di pesi (2.6):

250 g = peso di base

375 g = peso di base + 125 g

500 g = peso di base + 250 g

625 g = peso di base + 125 g + 250 g

750 g = peso di base + 500 g

875 g = peso di base + 125 g + 500 g

1000 g = peso di base + 250 g + 500 g

1125 g = peso di base + 125 g + 250 g + 500 g

1250 g = peso di base + 125 g + 125 g + 250 g + 500 g

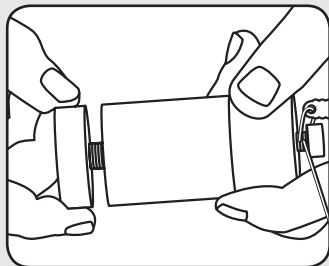

e) impostare le trazioni

Avviso: la trazione può essere aumentata attraverso pesi supplementari (non compresi nella fornitura).

Expandere a pesi correttamente applicato.

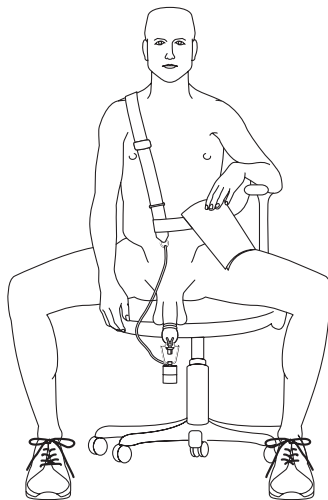

Varianti

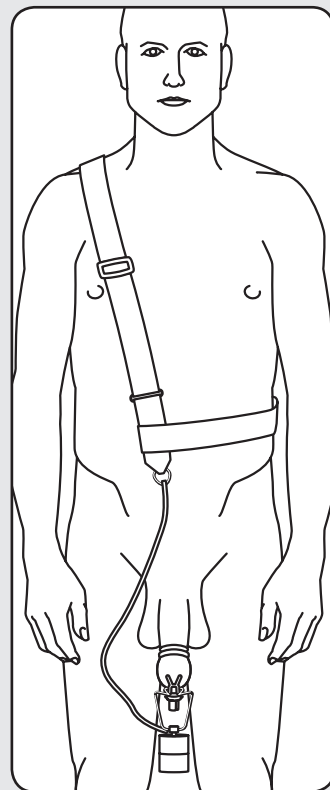
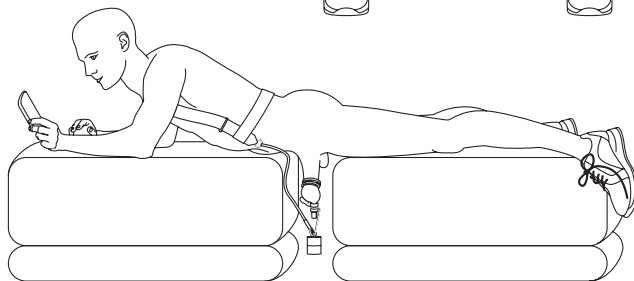

applicato correttamente

Nota editoriale

Produttore del sistema di espansione peniena PeniMaster® PRO ed editore del presente manuale e delle presenti istruzioni per l'uso

MSP Concept GmbH & Co. KG
Emser Str. 39 d
D-10719 Berlino
Germania

Telefono: +49 (0)30/23 63 85 65
Fax: +49 (0)30/21 75 26 11
E-mail: info@penimaster.de

it

Tribunale di Charlottenburg
Reg. di commercio HRA 33128
Partita IVA: DE202064651

rappresentata da

MSP Concept Verwaltungs GmbH
Sede: Berlino
Tribunale di Charlottenburg
Reg. di commercio: HRB 83666

rappresentata dal suo

Amministratore
Matthias Suchy

Grafica
ab-design GmbH, Berlino



es



PeniMaster® es una marca registrada de
MSP Concept GmbH & Co. KG

N.º de patente DE 10 2007 026 063

N.º de modelo registrado DE 20 2008 014 196

N.º de modelo registrado DE 20 2009 001 971

N.º de modelo registrado DE 20 2007 008 831

N.º de modelo registrado DE 20 2007 016 874

N.º de modelo registrado DE 20 2007 016 875

© Copyright 2018 MSP Concept GmbH & Co. KG
Versión: 02/2018. Todos los derechos reservados.

Copyright

Esta documentación está protegida por los derechos de autor. Quedan reservados todos los derechos, especialmente el derecho a la reproducción y divulgación, así como el de traducción.

Ninguna parte de esta publicación podrá ser reproducida de cualquier forma mediante fotocopia, microfilm ni otros procedimientos, ni transferirse en otro lenguaje aplicable en máquinas, especialmente en dispositivos de procesamiento de datos, sin el consentimiento del titular de los derechos.

Quedan reservados todos los derechos de reproducción pública.

Queda reservado el derecho a error o modificaciones de contenido, así como modificaciones que se deban al progreso técnico.



Lista de piezas y denominación de componentes del PeniMaster® PRO (generador de tracción con pesas)

N.º art. ZPMP-007



1

PeniMaster® PRO Sistema básico

N.º art. PMP-001

(no incluido en el volumen de suministro)

2

Generador de tracción con pesas para el sistema PeniMaster® PRO

N.º art. ZPMP-007

Pesa básica (250 g) con sistema de seguridad (2.1) y pesas redondas enroscables (2.6) de acero inoxidable. Fuerza de tracción ajustable en pasos de 125 gramos (de 250 g a 1250 g). Ampliable a placer con pesas adicionales.

2.1

Pesa básica 250 g

N.º art. ZPMP-008

Pesa redonda con rosca interior para enroscar a las pesas adicionales (2.6) y cinturón de seguridad integral (2.3 – 2.5).

2.2

Pieza de acoplamiento

Conecta el generador de tracción de las pesas (2) con el PeniMaster® PRO (1)

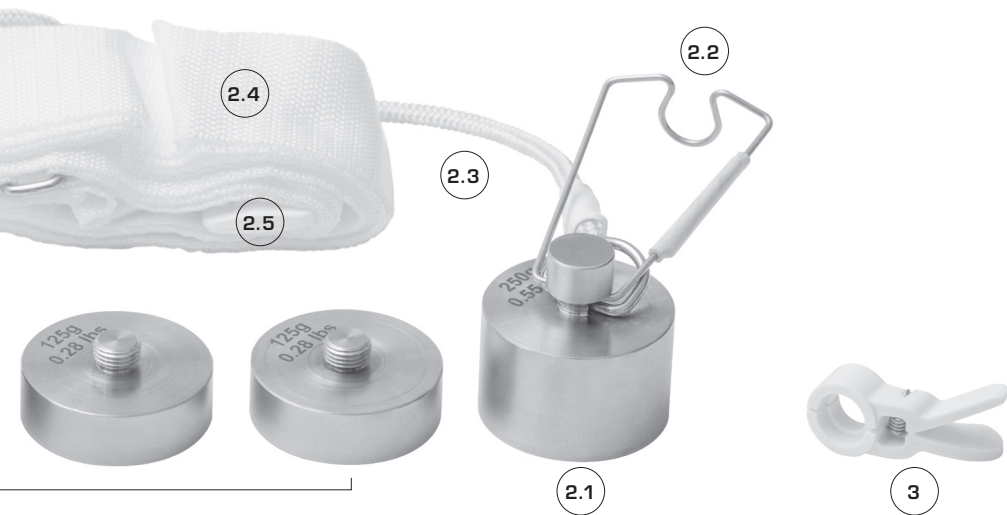

2.3 Cable de sujeción
Resistente a los desgarros, con una unión indivisible a la pesa básica.

2.4 Correa al hombro
Correa textil ancha y agradable a la piel. Se lleva alrededor de los hombros como una banda.

2.5 Hebillas
Para ajustar la altura del cinturón del hombro [2.4].

2.6 Pesas redondas
Pesas redondas de acero inoxidable. Se enroscan a la pesa básica (250 g) (2.1) y entre sí.

El volumen de suministro incluye:
2 x 125 g (ZPMP-009),
1 x 250 g (ZPMP-010),
1 x 500 g (ZPMP-011).

3 Seguro del acoplamiento
N.º art. ZPMP-012
Asegura la conexión del PeniMaster®PRO (1) y el generador de tracción de las pesas (2) fijando la pieza de acoplamiento. (2.2).

Colocación del expansor de pesas

Antes de comenzar

El expansor de pesas es un accesorio del PeniMaster®PRO básico. Por ello, lea también las instrucciones de uso del PeniMaster®PRO básico sobre el manejo correcto y los riesgos y efectos secundarios.

Indicaciones de peligros

¡Las pesas utilizadas generan en principio un riesgo cinético (energía de caída)!

- Por motivos de seguridad, póngase siempre la correa al hombro y utilice el seguro del acoplamiento conforme a estas instrucciones.
- ¡No deje caer hacia abajo el expansor de pesas colocado en el pene! ¡Ya con una caída de pocos centímetros existe peligro de lesiones!
- Muévase de forma lenta y controlada con el expansor de pesas colocado en el pene. No salte hacia arriba y abajo. Suba y baje las escaleras lentamente. No practique actividades deportivas.

Preparativos para la colocación.

[!] Ya tiene que haberse colocado el PeniMaster®PRO en el pene (véase la página 20 y sig. de las instrucciones del PeniMaster®PRO).

1. Colocación como expansor de pesas

- a) Pase un brazo por la correa y póngasela sobre la cabeza. Una vez colocada en el cuerpo, la hebilla (2.5) debe estar hacia delante.

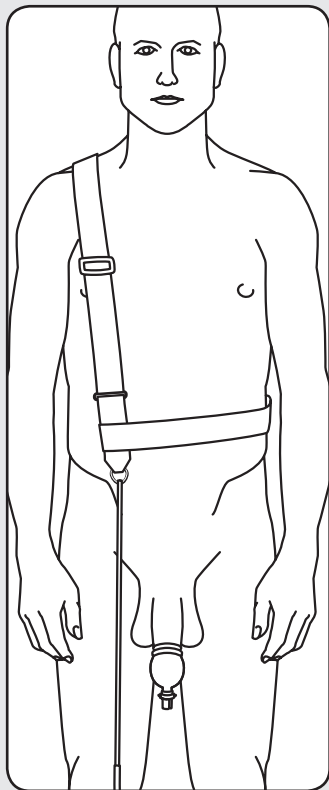

a) Colóquelo

- b) Ajuste con la hebilla (2.5) la correa al hombro (2.4) de tal manera que su extremo (con el aro metálico) se encuentre más o menos a la altura del ombligo.

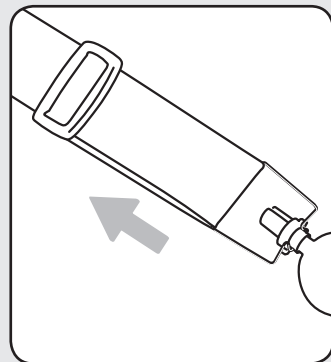

- b) Ajuste la longitud con la hebilla.*

- c) Apriete el segmento delgado del cabezal del acoplamiento del PeniMaster®PRO (1) en la combadura de la pieza de acoplamiento (2.2) y únalo a la pesa básica (2.1). De este modo ambas piezas quedarán sujetas una a la otra.

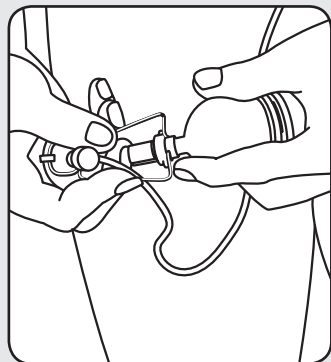

- c) Realice el acoplamiento.*

d) Abra el seguro del acoplamiento (3) presionando las aletas y fije el seguro del acoplamiento (3) al PeniMaster®PRO (1) tal y como aparece representado. .

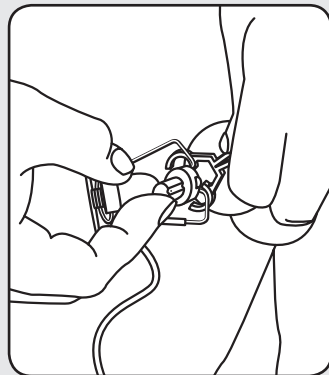

d) Ponga el seguro del acoplamiento.

e) Aumente la fuerza de tracción como desee enroscando y desenroscando las pesas redondas correspondientes (2.6) a la pesa básica (2.1). (Nota: Este paso también puede realizarse antes del paso c) si ya sabe la fuerza de tracción que desea.

Pueden ajustarse las siguientes fuerzas de tracción con el set de pesas (2.6):

- 250 g = pesa básica
- 375 g = pesa básica + 125 g
- 500 g = pesa básica + 250 g
- 625 g = pesa básica + 125 g + 250 g
- 750 g = pesa básica + 500 g
- 875 g = pesa básica + 125 g + 500 g
- 1000 g = pesa básica + 250 g + 500 g
- 1125 g = pesa básica + 125 g + 250 g + 500 g
- 1250 g = pesa básica + 125 g + 125 g + 250 g + 500 g

Nota: La fuerza de tracción puede seguir aumentándose a través de pesas adicionales (no incluidas en el volumen de suministro).

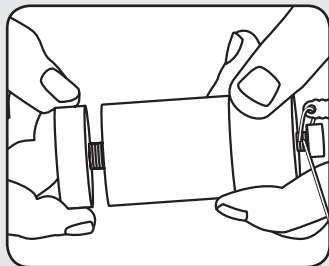

e) Ajuste la fuerza de tracción.

Sistema expansor de pesas colocado correctamente.

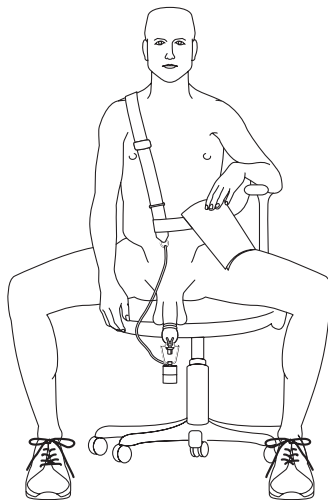

Variantes

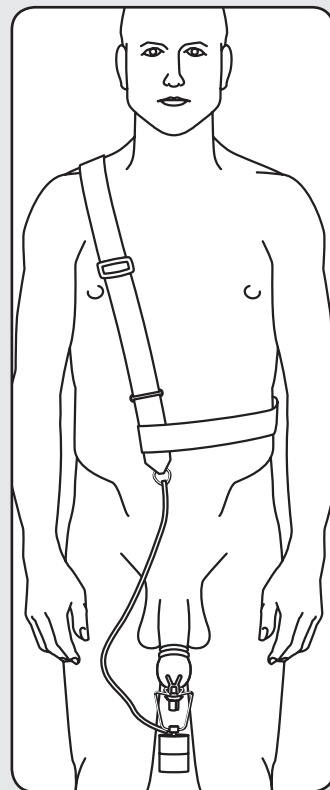
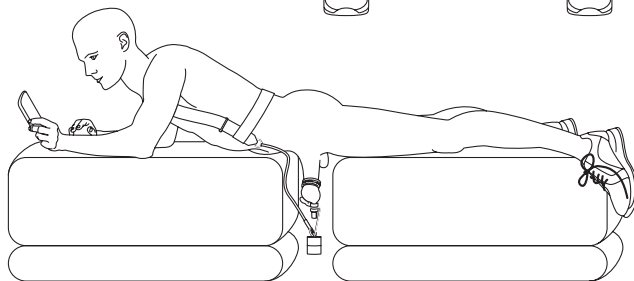

Colocado correctamente.

es

Aviso legal

Fabricante del sistema de expansor para el pene PeniMaster® PRO y editor de este manual y estas instrucciones de uso

MSP Concept GmbH & Co. KG
Emser Str. 39d
D-10719 Berlin
Alemania

Teléfono: +49 (0)30/23 63 85 65
Fax: +49 (0)30/21 75 26 11
Correo electrónico: info@penimaster.de

es Juzgado Municipal de Charlottenburg
HRA 33128
N.º ID IVA: DE202064651
representado por

MSP Concept Verwaltungs GmbH
Sede: Berlin
Juzgado Municipal de Charlottenburg
HRB 83666

representado por el

director general
Matthias Suchy

Diseño gráfico
ab-design GmbH, Berlin

Manual de instruções



pt

MSP CONCEPT
GMBH & CO. KG

PeniMaster® é uma marca registada da

MSP Concept GmbH & Co. KG

Patente n.º DE 10 2007 026 063

Direito de propriedade n.º DE 20 2008 014 196

Direito de propriedade n.º DE 20 2009 001 971

Direito de propriedade n.º DE 20 2007 008 831

Direito de propriedade n.º DE 20 2007 016 874

Direito de propriedade n.º DE 20 2007 016 875

© Copyright 2018 MSP Concept GmbH & Co. KG

Versão: 02/2018. Todos os direitos reservados.

Copyright

A presente documentação está protegida por direitos de autor. Todos os direitos, especialmente o direito de reprodução e distribuição, assim como da tradução, são reservados.

Nenhuma parte desta publicação deve ser reproduzida, de alguma forma, sem autorização por escrito do titular dos direitos, através de fotocópia, microfilme ou outro processo, ou deve ser transferida para uma linguagem utilizada para máquinas, em especial computadores.

Reservados todos os direitos de reprodução.

Estão reservadas as alterações do conteúdo e erros, assim como alterações que sirvam propósitos técnicos.



Lista de peças e designação das peças do PeniMaster® PRO (Produtor de força de tração por pesos)

Art. - N.º ZPMP-007



1 PeniMaster®PRO Sistema básico

Art. - N.º PMP-001

(não incluído no volume de fornecimento)

2 Produtor de força de tração por pesos Para sistema básico do PeniMaster®PRO

Art. - N.º ZPMP-007

Peso base (250 g) com sistema de segurança (2.1) e pesos redondos aparafusados (2.6) de aço inoxidável. Força de tração ajustável em incrementos de 125 gramas (de 250 g a 1250 g). Possível extensão com pesos adicionais.

2.1 Peso base 250 g

Art. - N.º ZPMP-008

Peso redondo com rosca interior para a aparafusar pesos adicionais (2.6) e cinto de segurança integral (2.3 – 2.5).

2.2 Suporte de acoplamento

Conecta o produtor de força de tração por pesos (2) com o PeniMaster®PRO (1)

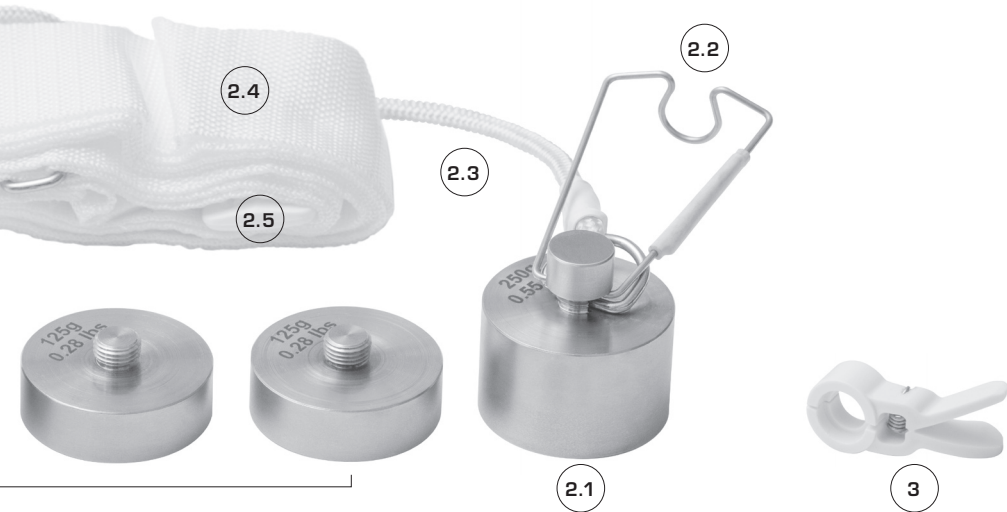

2.3 Cabo de retenção
Resistente à rutura, com conexão fixa ao peso base.

2.4 Correia de ombro
Correia de tecido largo, suave para a pele. É usada como uma faixa aos ombros.

2.5 Fivelas de guia
Para ajustar o comprimento da correia de ombro (2.4).

2.6 Pesos redondos
Pesos redondos de aço inoxidável. São aparafusados ao peso base (250 g) (2.1) e entre si.

O volume de fornecimento inclui:
2 x 125 g (ZPMP-009),
1x 250 g (ZPMP-010),
1 x 500 g (ZPMP-011).

3 Bloqueio de engate
Art. - N.º ZPMP-012
Bloqueia a conexão do Peni-Master®PRO (1) e do produtor de força de tração por pesos (2) através da fixação do suporte de acoplamento (2.2).

Colocação do extensor com pesos

Antes de começar

O expansor de pesos é um acessório para o PeniMaster®PRO Basis. Por isso, leia também o manual de instruções do PeniMaster®PRO Basis para obter informações sobre um correto manuseamento, assim como sobre os riscos e efeitos secundários.

Indicações de segurança

Os pesos usados constituem principalmente um perigo cinético (energia de impacto)!

- Por razões de segurança coloque sempre o suspensório e use o bloqueio de engate de acordo com este manual.
- Não deixe cair para baixo o expansor de pesos colocado no pênis! Mesmo com poucos centímetros de altura de queda existe o perigo de ferimentos!
- Com o expansor de pesos colocado no pênis, desloque-se lentamente e de modo controlado. Não salte nem pule para cima e para baixo. Suba e desça escadas lentamente. Não pratique quaisquer atividades desportivas.

Preparação para a colocação.

[!] Deverá ter o PeniMaster®PRO já colocado no pênis (ver página 20 ss das instruções do PeniMaster®PRO).

1. Colocação como extensor com pesos

- a) Insira um braço pela correia e puxe esta através da cabeça. Após a colocação no corpo a fivela de guia (2.5) deve apontar para a frente.

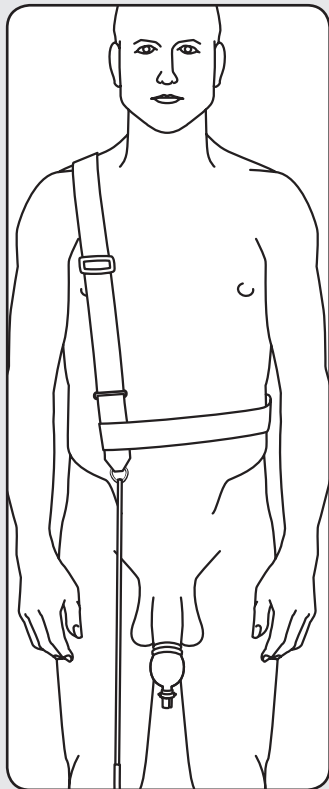

a) colocação

b) Com a fivela de guia (2.5) ajuste a correia de ombro (2.4) de modo que a sua extremidade (com o anel de metal) se encontre aproximadamente à altura do umbigo.

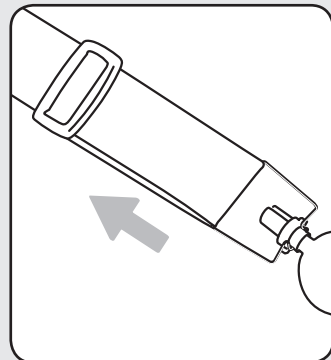

b) Ajustar o comprimento com a fivela de guia

c) Pressione o segmento estreito da cabeça de acoplamento do PeniMaster®PRO (1) na saliência do suporte de acoplamento (2.2) e puxe no peso base (2.1). Deste modo, ambas as peças são acopladas entre si.

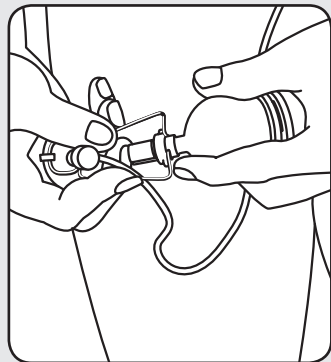

c) acoplar

d) Abra o bloqueio de engate (3) pressionando em conjunto o batente e prenda o bloqueio de engate (3) conforme representado no PeniMaster®PRO (1).

e) Aumente a força de tração conforme desejar aparafusando e aparafusando um no outro os respetivos pesos redondos (2.6) no peso base (2.1). (Indicação: Este passo pode ser também realizado antes do passo c), se já conhecer a força de tração pretendida).

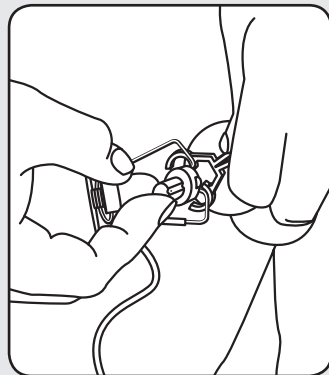

d) Encaixar o bloqueio de engate

pt As seguintes forças de tração podem ser reguladas com o conjunto de pesos (2.6):

250 g = Peso base

375 g = Peso base + 125 g

500 g = Peso base + 250 g

625 g = Peso base + 125 g + 250 g

750 g = Peso base + 500 g

875 g = Peso base + 125 g + 500 g

1000 g = Peso base + 250 g + 500 g

1125 g = Peso base + 125 g + 250 g + 500 g

1250 g = Peso base + 125 g + 125 g + 250 g + 500 g

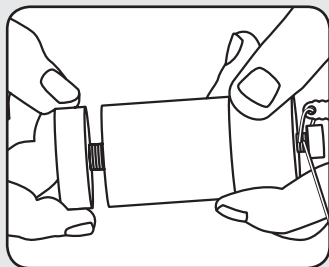

e) Ajustar as forças de tração

Indicação: A força de tração pode ser aumentada através dos pesos adicionais (não incluídos no volume de fornecimento).

Sistema de extensores com pesos colocado corretamente.

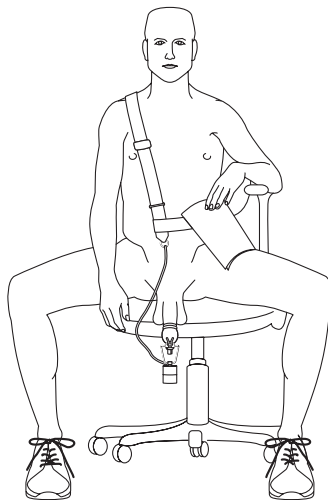

Variantes

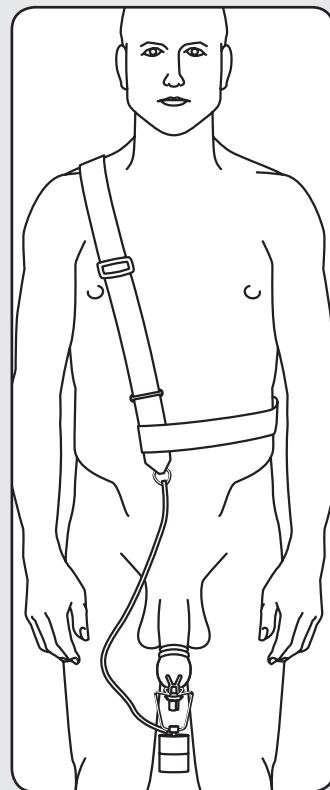
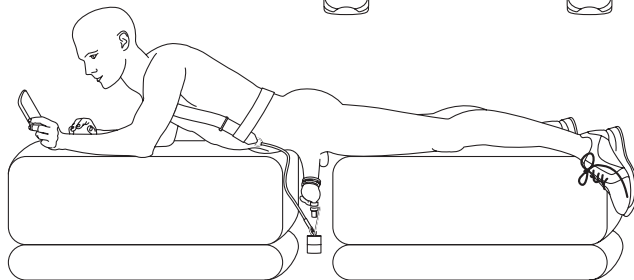

colocado corretamente

Ficha técnica

**Fabricante do sistema de extensores de pênis PeniMaster® PRO,
Editor deste manual e destas instruções de uso.**

MSP Concept GmbH & Co. KG
Emser Str. 39d
D-10719 Berlim
Alemanha

Telefone: +49 (0)30 / 23 63 85 65
Fax: +49 (0)30 / 21 75 26 11
E-Mail: info@penimaster.de

Tribunal da Comarca de Charlottenburg
HRA 33128
N.º de contribuinte: DE202064651

Representados por

MSP Concept Verwaltungs GmbH
Sede: Berlim
Tribunal da Comarca de Charlottenburg
HRB 83666

Representados por

Administrador
Matthias Suchy

Design gráfico
ab-design GmbH, Berlim

Инструкция



MSP CONCEPT
GMBH & CO. KG

PeniMaster® является зарегистрированным товарным знаком фирмы
MSP Concept GmbH & Co. KG

Патент № DE 10 2007 026 063

Полезная модель № DE 20 2008 014 196

Полезная модель № DE 20 2009 001 971

Полезная модель № DE 20 2007 008 831

Полезная модель № DE 20 2007 016 874

Полезная модель № DE 20 2007 016 875

© 2018 Авторские права принадлежат MSP Concept GmbH & Co. KG

Редакция от 02/2018. Все права защищены.

Авторские права

Настоящая документация защищена авторским правом. Все права, в частности, право на воспроизведение и распространение, а также перевод сохраняются за автором.

Ни одну из частей этой публикации не разрешается репродуцировать без письменного согласия владельца прав ни в какой форме: путем фотокопирования, микрофильмирования или иным способом, или переводить на язык программирования, применимый для машин, в частности, устройств для обработки данных.

Все права на воспроизведение сохраняются за автором.

Исключая ошибки и пропуски, автор сохраняет за собой право на изменения содержания, а также изменения, которые служат техническому прогрессу.



Перечень и назначение деталей PeniMaster® PRO (Система для подвешивания)

Арт. № ZPMP - 007



- 1 PeniMaster®PRO
Базисная система**
Арт. № PMP - 001
(не входит в комплект)



- 2 Система для подвешивания
Для аппарата PeniMaster®PRO**
Арт. № ZPMP-007

Состоит из базового грузика (250 г) с ремнем безопасности (2.1) и ввинчивающихся грузиков цилиндрической формы, изготовленных из нержавеющей стали (2.6). Тяговое усилие можно регулировать с шагом 125 г (диапазон от 250 г до 1250 г). Тяговое усилие увеличивается с помощью дополнительных грузиков.



- 2.1 Базовый грузик 250 г**
Арт. № ZPMP-008

Грузик цилиндрической формы с внутренней резьбой для ввинчивания дополнительных грузиков (2.6) и встроенного ремня безопасности (2.3 – 2.5).

- 2.2 Стыковочное гнездо**
Предназначено для соединения системы для подвешивания (2) с PeniMaster®PRO (1).

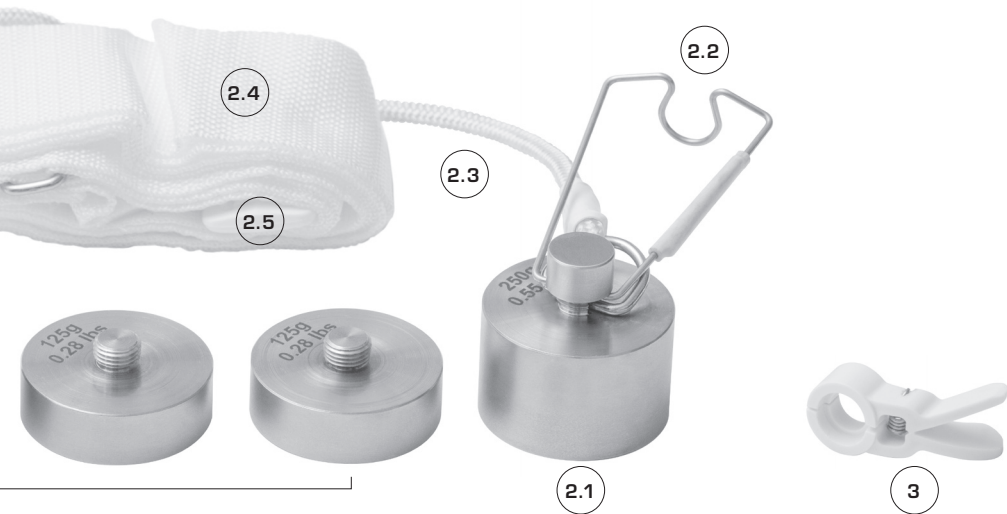

2.3 **Предохранительный шнур**
Устойчив к разрыву, с фиксированным креплением к базовому грузу.

2.4 **Плечевой ремень**
Широкий, изготовлен из гипоаллергенного материала. Надевается через плечо.

2.5 **Ступенчатые пряжки**
Для регулировки длины плечевого ремня (2.4).

2.6 **Грузики цилиндрической формы**
Цилиндрические грузики изготовлены из нержавеющей стали. С резьбовым креплением к базовому грузу (250 г) (2.1) и друг к другу.

В комплект входят:
2 x 125 г (ZPMP-009),
1 x 250 г (ZPMP-010),
1 x 500 г (ZPMP-011).

3 **Фиксирующий зажим**
Арт. № ZPMP-012
Обеспечивает безопасность соединения PeniMaster®PRO (1) с системой для подвешивания (2) путем фиксации стыковочного гнезда (2.2).

Использование экспандера на основе подвешивания

Прежде чем начать

Экспандер на основе подвешивания является аксессуаром к базисной системе PeniMaster[®]PRO. Пожалуйста, ознакомьтесь по этому с инструкцией по применению базисной системы PeniMaster[®]PRO для правильного обращения, а также в отношении рисков и побочных эффектов.

Указания на опасности

От используемых грузиков, в принципе, исходит кинетическая опасность (энергия падения)!

- Из соображений безопасности всегда надевайте плечевой ремень и используйте фиксирующий зажим в соответствии с инструкцией.
- Не допускайте падения наложенного на пенис экспандера на основе подвешивания! Даже с высоты падения в несколько сантиметров существует риск получения травмы!
- Двигайтесь с наложенным на пенис экспандером на основе подвешивания медленно и контролируемо. Не подсакивайте и не прыгайте вверх и вниз. Ходите по лестнице вверх и вниз медленно. Не выполняйте спортивных упражнений.

Подготовка к использованию:

[!] Камера PeniMaster[®]PRO должна быть уже надета на половой член (см. стр. 20 и далее инструкции к PeniMaster[®]PRO).

1. Использование экспандера на основе подвешивания

- a) Наденьте ремень через плечо. Ступенчатая пряжка должна (2.5) находиться спереди.

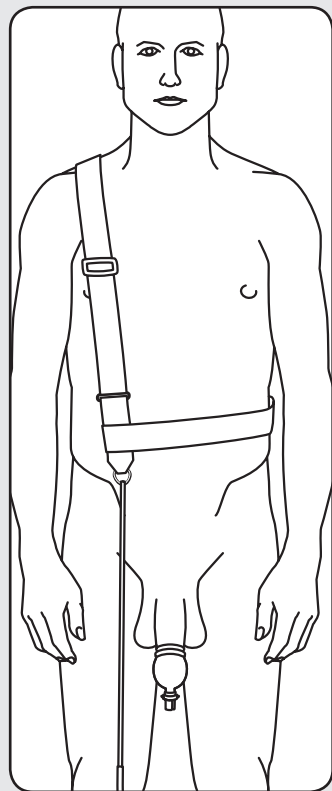

a) Наденьте ремень

- б) С помощью пряжки (2.5) отрегулируйте длину плечевого ремня (2.4) таким образом, чтобы его конец (с металлическим кольцом) находился приблизительно на уровне пупка.

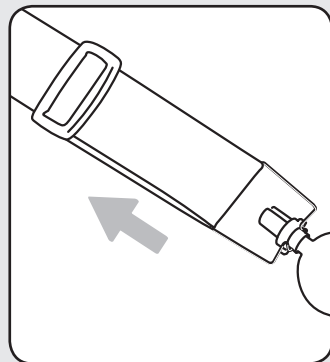

- б) С помощью пряжки отрегулируйте длину

- в) Вдавите узкую часть камеры PeniMaster[®]PRO (1) в выемку стыковочного гнезда (2.2) и потяните за базовый грузик (2.1). Тем самым вы соедините обе части.

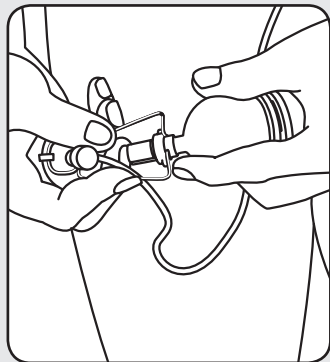

- в) Соедините обе части

г) Откройте фиксирующий зажим (3), сжав его с двух сторон, и закрепите его (3) на камере PeniMaster®PRO (1), как показано на рисунке.

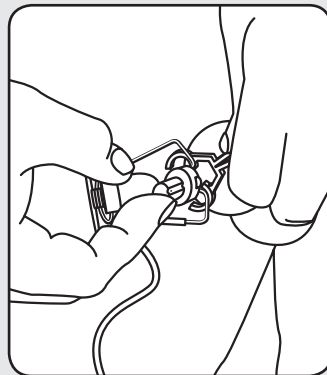

г) Закрепите фиксирующий зажим

д) Если необходимо, увеличьте тяговое усилие путем навинчивания грузиков нужной массы (2.6) на базовый грузик (2.1). (Примечание: это можно сделать до шага в), если вы уже знаете, какое тяговое усилие вам требуется).

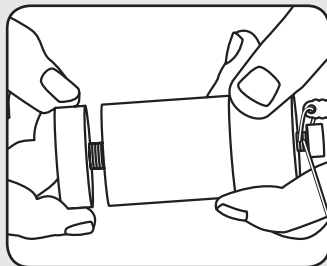

д) Отрегулируйте тяговое усилие

Тяговое усилие регулируется при помощи грузиков (2.6):

250 г = базовый грузик

375 г = базовый грузик + 125 г

500 г = базовый грузик + 250 г

625 г = базовый грузик + 125 г + 250 г

750 г = базовый грузик + 500 г

875 г = базовый грузик + 125 г + 500 г

1000 г = базовый грузик + 250 г + 500 г

1125 г = базовый грузик + 125 г + 250 г + 500 г

1250 г = базовый грузик + 125 г + 125 г + 250 г + 500 г

Примечание: дальнейшее увеличение тягового усилия возможно за счет крепления дополнительных грузиков (не входят в комплект).

Так выглядит надлежащим образом надетый экспандер на основе подвешивания

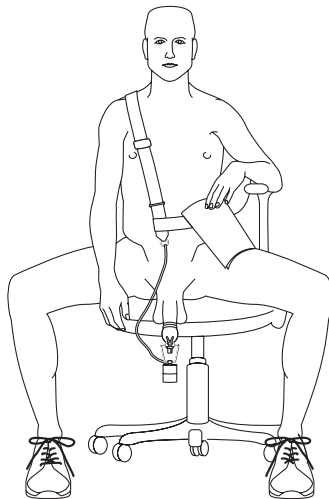

варианты

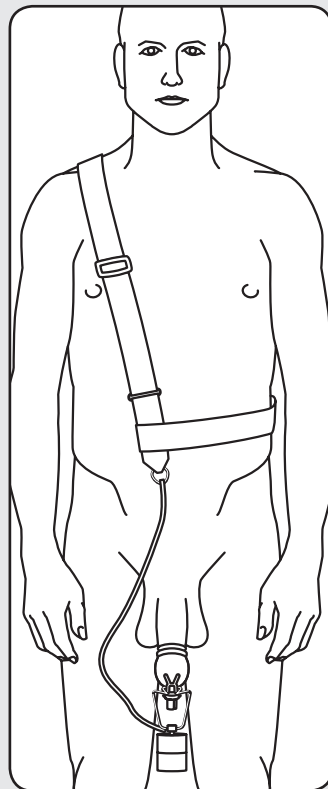
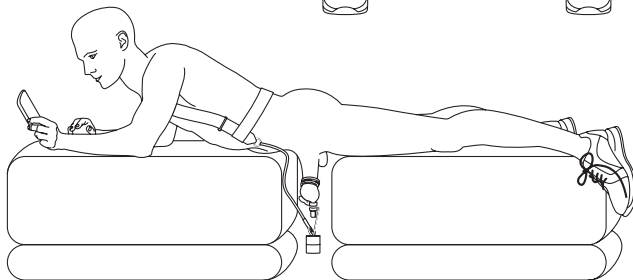

Правильно

Правовая оговорка

**Изготовитель экспандерной системы для полового члена PeniMaster® PRO
и издатель этого Руководства и этой Инструкции по применению**

MSP Concept GmbH & Co. KG
Emser Str. 39 d
D-10719 Berlin
Germany

Телефон: +49 (0)30/23 63 85 65
Факс: +49 (0)30/21 75 26 11
E-Mail: info@penimaster.de

Суд первой инстанции Шарлоттенбурга
Reg. № HRA 33128
Идент. номер плательщика налога с оборота: DE202064651

ru

Представитель

MSP Concept Verwaltungs GmbH
Местонахождение: Берлин
Суд первой инстанции Шарлоттенбурга
Reg. № HRB 83666

в лице

исполнительного директора
Matthias Suchy

Графика
ab-design GmbH, Берлин

El kitabı



tr PeniMaster ®, MSP Concept GmbH & Co. KG
şirketinin tescilli bir markasıdır
Patent no. DE 10 2007 026 063
Kullanım numunesi no. DE 20 2008 014 196
Kullanım numunesi no. DE 20 2009 001 971
Kullanım numunesi no. DE 20 2007 008 831
Kullanım numunesi no. DE 20 2007 016 874
Kullanım numunesi no. DE 20 2007 016 875

© Copyright 2018 MSP Concept GmbH & Co. KG

Baskı: 02/2018. Tüm hakları saklıdır.

Telif hakkı

Mevcut doküman telif hakkı yasalarınca korunmuştur.

Tüm haklar, özellikle çoğaltma, yayınlama ve tercüme hakkı bizde saklıdır.

Hak sahibinin yazılı onayı olmaksızın bu yayının hiçbir kısmının fotokopi, mikrofilm veya başka yollarla çoğaltılması veya makineler ve veri işleme sistemleri için kullanılabilir bir dile aktarılması yasaktır.

Diğer bütün hakları saklı kalır.

Teknik geliştirme amacıyla içerikle ilgili değişiklik yapma hakkı ve hata yapma hakkı saklıdır.



Parça listesi ve parçaların adı PeniMaster® PRO (ağırlık çekiş kuvveti oluşturucusu)

Ür. no. ZPMP-007



2



2.6

1 PeniMaster® PRO Temel sistem

Ür. no. PMP-001

(teslimat kapsamına dahil değildir)

2 Ağırlık çekiş kuvveti oluşturucusu PeniMaster® PRO sistemi için

Ür. no. ZPMP-007

Temel ağırlık (250 g), emniyet sistemi (2.1) ve paslanmaz çelikten yapılmış vidalanabilir yuvarlak ağırlıklar (2.6). Çekiş kuvveti 125 gramlık adımlarla ayarlanabilir (250 g – 1250 g arası). İlave ağırlıklarla istenildiği gibi genişletilebilir.

2.1 Temel ağırlık 250 g

Ür. no. ZPMP-008

Yuvarlak ağırlık, ilave ağırlıkları (2.6) vidalamaya yarayan vida dişleri ve entegre emniyet kemeri (2.3 – 2.5).

2.2 Bağlantı aparatı

Ağırlık çekiş kuvveti oluşturucusunu (2) PeniMaster® PRO (1) ile birleştirir.

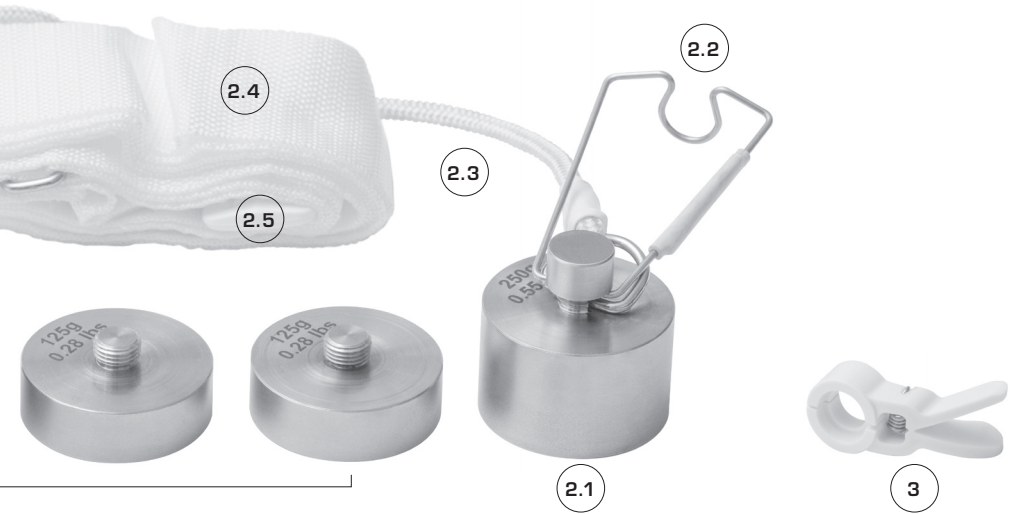

2.3 **Yakalama halatı**
Kopmaz, temel ağırlıklı kopmayan bağlantıya sahip.

2.4 **Omuz kemeri**
Geniş, cilde uyumlu dokuya sahip kemer. Bir omuz atkısı gibi omzun üzerinde taşınır.

2.5 **Tokalar**
Omuz kemerinin (2.4) uzunluğunu ayarlamak için.

2.6 **Yuvarlak ağırlıklar**
Paslanmaz çelikten yapılmış yuvarlak ağırlıklar. Temel ağırlığa (250 g) (2.1) ve iç içe vidalanır.

Teslimat kapsamında şunlar bulunur:
2 x 125 g (ZPMP-009),
1 x 250 g (ZPMP-010),
1 x 500 g (ZPMP-011).

3 **Bağlantı emniyeti**
Ür. no. ZPMP-012
PeniMaster®PRO (1) ile ağırlık çekiş kuvveti oluşturucusu (2) arasındaki bağlantıyı, bağlantı aparatını (2.2) sabitleyerek emniyete alın.

Ağırlık artırıcının takılması

Başlamadan önce

Ağırlık genişletme seti, PeniMaster®PRO Basis'in bir aksesuarıdır. Doğru kullanım, riskler ve yan etkiler hakkında bilgi edinmek için PeniMaster®PRO Basis'in kullanım kılavuzunu da okuyun.

Tehlike uyarıları

Kullanılan ağırlıktan dolayı prensipte bir kinetik tehlike (düşme enerjisi) söz konusudur!

- Güvenlik nedenlerinden dolayı bu ağırlıkları her zaman omuz kemerinden geçirin ve bu kılavuza uygun olarak kaplin emniyetini kullanın.
- Penise bağlanan ağırlık genişletme setini aşağı düşürmeyin! Birkaç santimetre düşüş yüksekliğinden dolayı bile yaralanma tehlikesi söz konusudur!
- Penise bağlanan ağırlık genişletme setiyle dikkatlice ve kontrollü hareket edin. Aşağı yukarı zıplamayın veya atlamayın. Merdivenleri yavaşça çıkın ve inin. Sportif aktiviteler yapmayın.

Takmaya hazırlık.

[!] PeniMaster®PRO ünitesini penisinize takmış olmanız gerekir (PeniMaster®PRO kılavuzunun 20. sayfasına bakın).

1. Ağırlık artırıcı olarak takılması
 - a) Bir kolunuzu kemerden geçirin ve kemeri kafanızdan geçirin. Taktıktan sonra ayar tokası (2.5) öne doğru bakmalıdır.

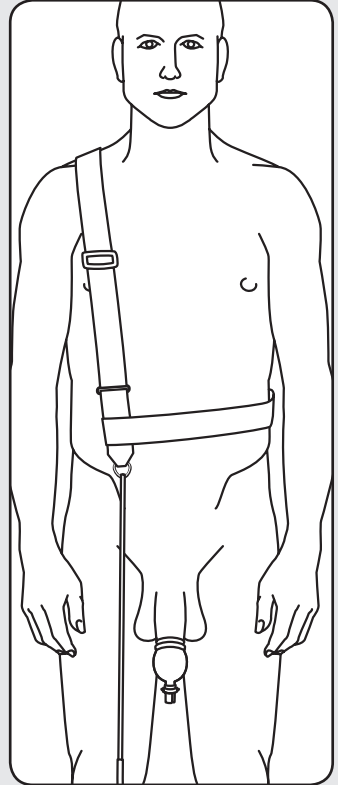

a) takmak

- b) Ayar tokasıyla (2.5) omuz kemerini (2.4), ucu (metal halkayla birlikte) göbek deliğiyle aynı yükseklikte bulunacak şekilde ayarlarsınız.

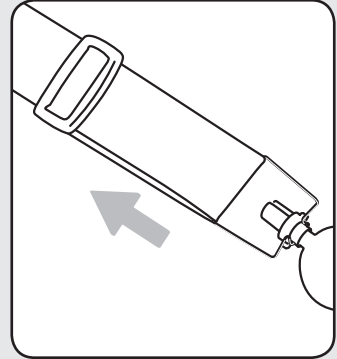

b) Ayar tokasıyla uzunluęu ayarlamak

- c) PeniMaster®PRO (1) ünitesinin bağlantı kafasına ait dar kısmı bağlantı aparatının (2.2) yuvasına bastırın ve temel ağırlığı (2.1) çekin. Bu sayede her iki parça birbirleriyle birleşir.

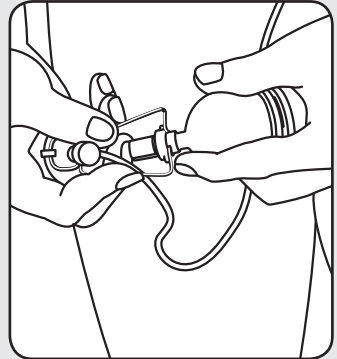

c) birleřtirmek

d) Kanatları birbirine bastırarak bağlantı emniyetini (3) açın ve kaplin emniyetini (3) gösterildiği gibi PeniMaster®PRO (1) ünitesine yerle tirin.

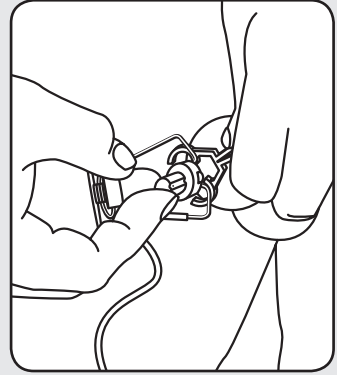

d) Bağlantı emniyetini açmak

e) Uygun yuvarlak ağırlıkları (2.6) temel ağırlığa (2.1) takarak ve iç içe vidalayarak çekiş kuvvetini istediğiniz şekilde yükseltin. (Not: İstenilen çekiş kuvvetini biliyorsanız, bu adım c) adımından önce de yapılabilir).

Ağırlık setiyle (2.6) aşağıdaki çekiş kuvvetleri ayarlanabilir:

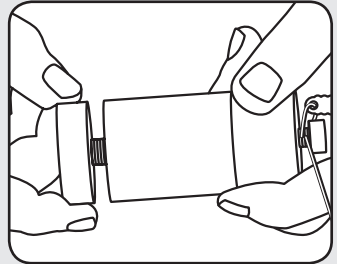

e) Çekiş kuvvetlerini ayarlamak

250 g = Temel ağırlık

375 g = Temel ağırlık + 125 g

500 g = Temel ağırlık + 250 g

625 g = Temel ağırlık + 125 g + 250 g

750 g = Temel ağırlık + 500 g

875 g = Temel ağırlık + 125 g + 500 g

1000 g = Temel ağırlık + 250 g + 500 g

1125 g = Temel ağırlık + 125g + 250 g + 500 g

1250 g = Temel ağırlık + 125g + 125 g + 250 g + 500 g

Not: İlave ağırlıklarla (teslimat kapsamına dahil değildir) çekiş kuvveti artırılabilir.

Dođru takılmıř ađırlık artırma sistemi.

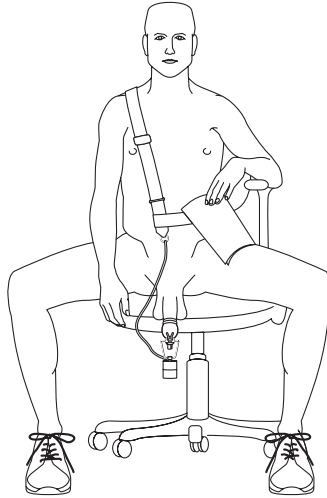

Varyantları

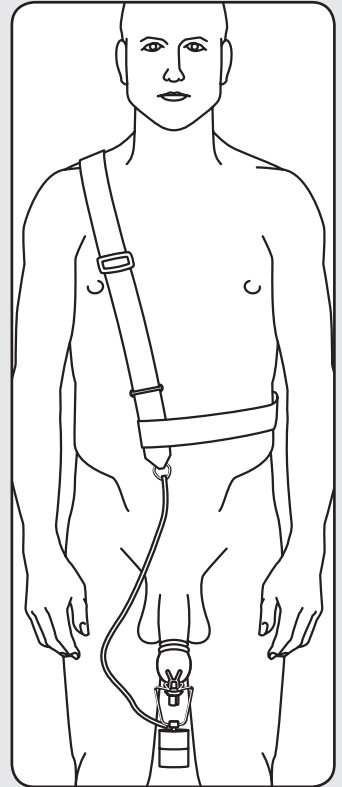
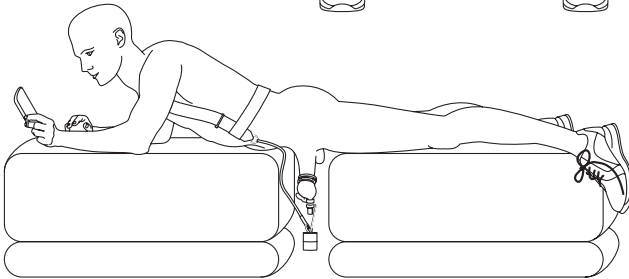

dođru takılmıř

Künye

Penis büyüme sistemi PeniMaster® PRO 'nun üreticisi bu el kitabının ve kullanım kılavuzunun yayımcısı

MSP Concept GmbH & Co. KG
Emser Str. 39 d
D-10719 Berlin
Almanya

Telefon: +49 (0)30/23 63 85 65
Faks: +49 (0)30/21 75 26 11
E-posta: info@penimaster.de

Charlottenburg Sulh Mahkemesi
HRA 33128
Vergi no.: DE202064651

Temsilcisi:

tr MSP Concept Verwaltungs GmbH
Merkez: Berlin
Charlottenburg Sulh Mahkemesi
HRB 83666

Temsilcisi:

Genel müdür
Matthias Suchy

Grafik
ab-design GmbH, Berlin

